

Finde die Karten, die zusammenpassen !

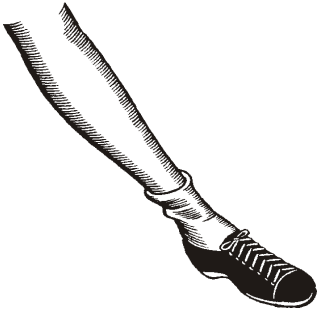

BEIN



DREI

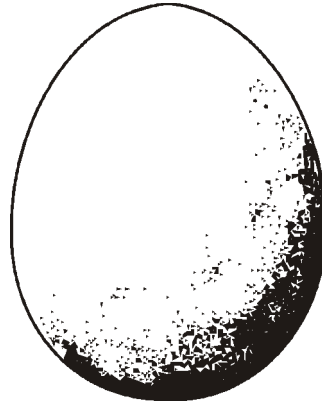

EI

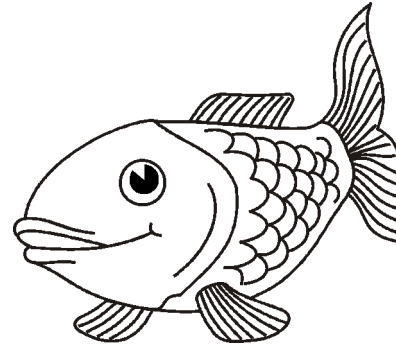

FISCH

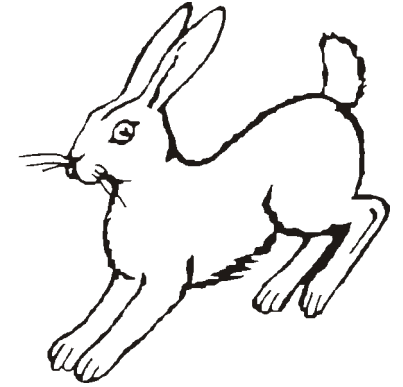

HASE

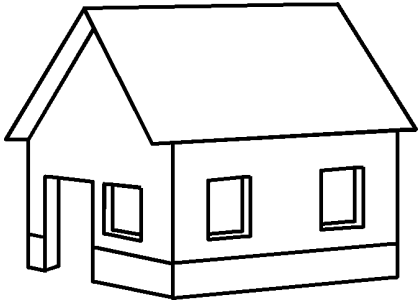

HAUS



LÜCKE

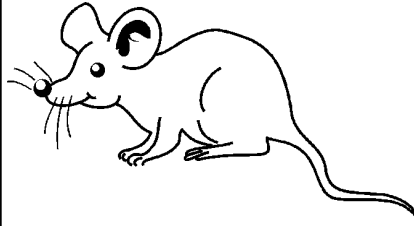

MAUS



MÜCKE



MUND



NASE

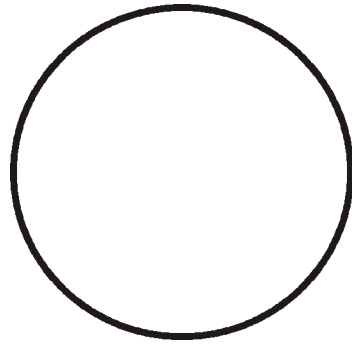

RUND



SCHWEIN

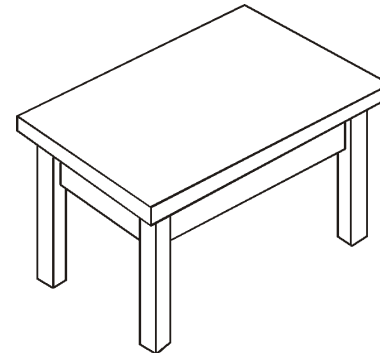

TISCH